







Modus

MOD25

Modular Lavatory System

 <p>with skirt: 25" x 22^{1/8}" x 15^{3/8}"</p> <p>without skirt: 25" x 22^{1/8}" x 8^{3/4}"</p>	 <p>0.35 gpm</p>	  <p>IAPMO Z124-2011/CSA B45.5-11 IAPMO IGC156 ASME A112.18.2-2011/CSA B125.2-11</p>	 <p>Drain: 1 1/2" Supplies: 1/2" IPS Inlet Pressure: 20-100 psi</p>	 <p>Compliance: ADA TAS Alberta Building Code (all models) Ontario Barrier Free (A-model, CAN-version) BC Building Code (all models) Code Construction Québec (Modèles A)</p>
---	---	--	--	---

Material & Construction

The bowl is made from anti-microbial solid surface. AquaDesign's solid surface is a composite material of acrylic polyester polymer resins and aluminum trihydrate fillers. The material is resistant to stains and burns and complies with ANSI Z124.3. Solidsurface cleans easily with Scotchbrite®, household cleaners or fine grit sandpaper. The Modus lavatory is available in [25 colors](#).

The Modus includes a heavy gauge stainless steel hidden support bracket.

The Modus is supplied with integral drain and a stainless steel drain pan.

Anti-microbial

The Modus bowl and shelves are manufactured with an anti-microbial agent. The agent is present both on the surface and on the inside of the material and will not dissipate or scratch off. In contact with moisture, anti-microbial ions will be released and effectively kill bacteria.

Standard Equipment

A-model: Lavatory in anti-bacterial solid surface material, stainless steel mounting bracket, stainless drainpan with tail piece.

B-model: Lavatory in anti-bacterial solid surface material, stainless steel mounting bracket, stainless drainpan with tail piece, stainless steel skirt and bottom plate.

Optional Equipment

The Modus can be supplied with any of AquaDesign's sensor faucets or soap dispensers or can be drilled for faucets by others.

Configurations

The Modus can be supplied with custom length side shelves. The length of the shelves can vary between 5" and 30". The shelves can be used to connect to other Modus fixtures or to connect to the wall.

The Modus can also be installed with the optional Modus baby changer unit.

LEED Compliance

When supplied with AquaDesign's faucets, The Modus contributes to meeting LEED requirements in the following categories:

- WEp1 - Water Efficiency
- WEc3 - Water Use Reduction

The nozzles have a flow rate of 0.35 gpm.

Application



The Modus is not to be used to dispense water for human consumption either by drinking or use in the preparation of food or beverages.

Warranty

5 years limited warranty on material, 1 year limited warranty on AquaDesign faucets.

SAMPLE SPECIFICATION

Fixture shall be an AquaDesign Modus 25" hand wash station. Bowl is made from anti-microbial solid surface. The unit will have an integral seamless drain.

The unit is furnished with a Line6/Line7/Line8/Line9 faucet.



WARNING: Cancer and Reproductive Harm
www.P65Warnings.ca.gov

Front View

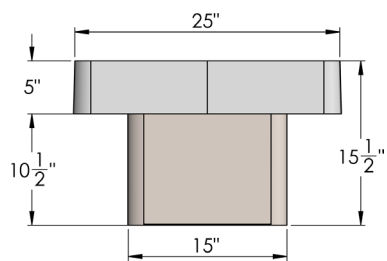

with stainless skirt

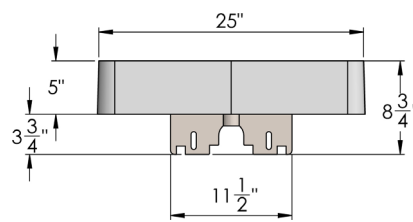

no skirt

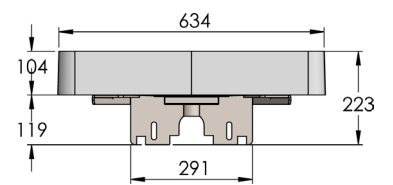

-CAN model

Top View

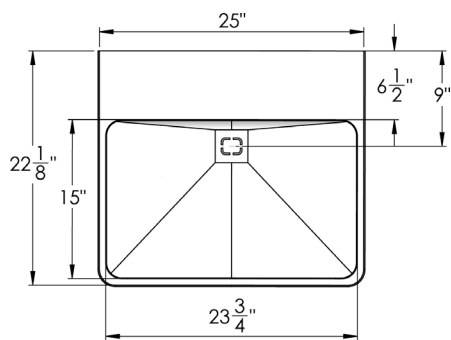

Carrier Plate

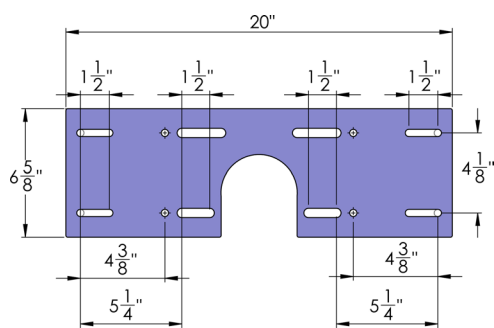

Side View Standard Height

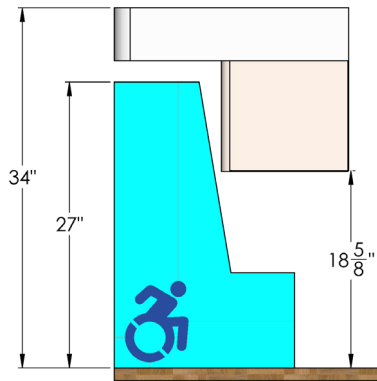

with stainless skirt

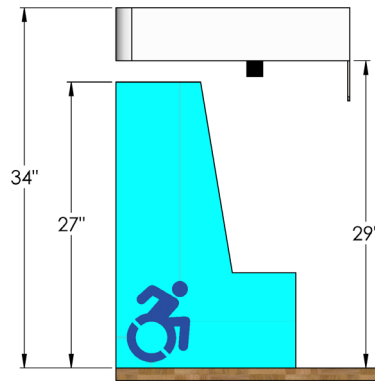

no skirt

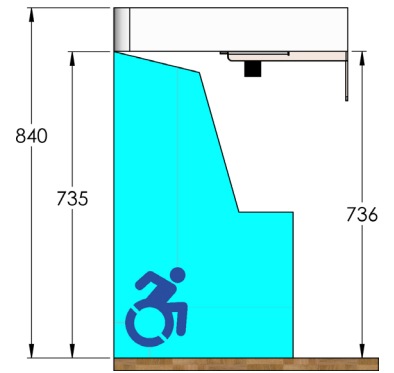

-CAN model
Ontario Barrier Free

Rough-In Dimensions

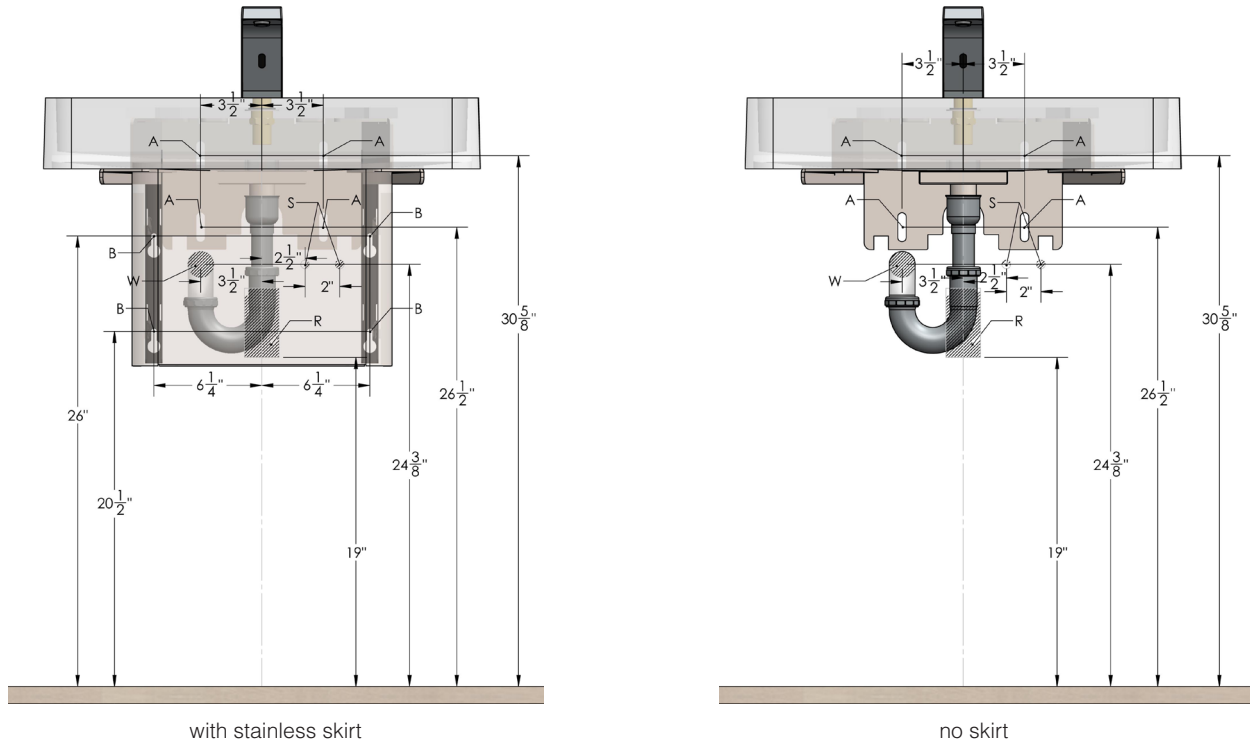

Code	Description
A	3/8" Anchors
B	1/4" Anchors
R	110V GFCI Outlet
W	1-1/2" NPT Drain
S	1/2" Supply (hot and cold)

Notes:

1. Electrical receptacle must be wired to a GFCI protected circuit. Fixture must be earth grounded.
2. Consult local electrical code for need and use of extra electrical conduit box.

Height Adjustments

Standard	Rim Height	Adjustment of A, B & W
ADA & TAS Adult	34"	None
ADA Juvenile, Age 6-12	31"	Subtract 3" from height in drawing
TAS, Grades 6 through 8 or 9	32"	Subtract 2" from height in drawing
TAS, Grades Pre-K through Grades 5 or 6	30"	Subtract 4" from height in drawing
Alberta and BC Building Code	865 mm	None
Ontario Barrier Free	840 mm	Subtract 24 mm (1") from height in Drawing
Code de Construction Québec	865 mm	Aucune

001	Base Model Number (must specify)	
<input type="checkbox"/>	MOD25	Modus Single User Lavatory
<input type="checkbox"/>	MOD25CAN	Modus Single User Lavatory - Ontario Barrier Free Compliant
002	Skirt (must specify)	
<input type="checkbox"/>	-A	No Skirt
<input type="checkbox"/>	-B	Stainless Steel Skirt
003	Operation (must specify)	
<input type="checkbox"/>	-L06	Line 6 Faucet
<input type="checkbox"/>	-L07	Line 7 Faucet
<input type="checkbox"/>	-L08	Line 8 Faucet
<input type="checkbox"/>	-L09	Line 9 Faucet
<input type="checkbox"/>	-DEK	No Faucet
004	Supply (must specify)	
<input type="checkbox"/>	-TEM	Tempered or Cold Water
<input type="checkbox"/>	-TMV	Thermostatic Mixing Valve
005	Color (must specify)	
	<u>Standard Colors</u>	
<input type="checkbox"/>	-AB	Adobe Brown
<input type="checkbox"/>	-AW	Ash White
<input type="checkbox"/>	-CG	Country Green
<input type="checkbox"/>	-CO	Concrete Grey
<input type="checkbox"/>	-DB	Designer Black
<input type="checkbox"/>	-ES	Egyptian Sand
<input type="checkbox"/>	-MB	Midnight Blue
<input type="checkbox"/>	-MG	Misty Grey
<input type="checkbox"/>	-PB	Pearl Black
<input type="checkbox"/>	-PW	Polar White
<input type="checkbox"/>	-SA	Sandstone
<input type="checkbox"/>	-TG	Twilight Grey
	<u>Designer Colors</u>	
<input type="checkbox"/>	-AC	Amalfi Coast
<input type="checkbox"/>	-BB	Belgian Blue
<input type="checkbox"/>	-BF	Black Forrest
<input type="checkbox"/>	-CA	Carrara Grey
<input type="checkbox"/>	-CC	Cebolla Creek
<input type="checkbox"/>	-CP	Caledonia Pearl
<input type="checkbox"/>	-PC	Portofina Crema
<input type="checkbox"/>	-PS	Paris Stone
<input type="checkbox"/>	-RS	San Cristobal Silver
<input type="checkbox"/>	-SR	Sydney Rock Oyster
<input type="checkbox"/>	-UB	Ubatuba Brown
<input type="checkbox"/>	-VM	Vienna Mist
006	Soap (for -A models only)	
<input type="checkbox"/>	-SD7	Line 7 Soap Dispenser
<input type="checkbox"/>	-SD8	Line 8 Soap Dispenser
<input type="checkbox"/>	-SD9	Line 9 Soap Dispenser
007	Other Options	
<input type="checkbox"/>	-HW	Plug-in Transformer
<input type="checkbox"/>	-CP	Carrier Plate for Mounting
<input type="checkbox"/>	-SR	Fixture modified for shelf or baby changer on right hand side
<input type="checkbox"/>	-SL	Fixture modified for shelf or baby changer on right hand side
<input type="checkbox"/>	-CS	Drilling for center set faucet by others
<input type="checkbox"/>	-4C	Drilling for 4" center faucet by others
<input type="checkbox"/>	-8C	Drilling for 8" center faucet by others

Approved by:

Name: _____

Title: _____

Signature: _____

All information including dimensions, changes in design and material are subject to manufacturer's change without formal notice and without obligation. AquaDesign assumes no responsibility for use of superseded or voided information. Verify all rough-in information before installation. It is the responsibility of the installer to conform with local and national codes.