



Modus

MVS/ESxx/CP

Accessories for the Modus Lavatory System

SHELVES

Material & Construction

The Modus shelves are made from anti-microbial solid surface. AquaDesign's solid surface is a composite material of acrylic polyester polymer resins and aluminum trihydrate fillers. The material is resistant to stains and burns and complies with ANSI Z124.3. Solid surface cleans easily with Scotchbrite®, household cleaners or fine grit sandpaper. The shelves are available in [25 colors](#).

The Modus shelves are supplied with heavy gauge steel mounting brackets.

Anti-microbial

The Modus shelves are manufactured with an anti-microbial agent. The agent is present both on the surface and on the inside of the material and will not dissipate or scratch off. In contact with moisture, anti-microbial ions will be released and effectively kill bacteria.

Standard Equipment

5", 7", 10" or custom length shelf (5" to 30") with heavy gauge support brackets.

Optional Configurations

All shelves longer than 10" can be supplied with an opening for trash. The 6" opening can either be round (-TCR) or square (-TRS) CARRIER PLATE

Carrier Plate

The Modus lavatories can be supplied with a steel plate for plate carriers. The plate has the hole pattern conforming for any of the Modus-Vivendi lavatories. One plate is required for the MOD25 and VIV20 lavatories, 2 plates are required for the VIV50 lavatory. Fixture support studs and U-bolts are supplied by others.



WARNING: Cancer and Reproductive Harm
www.P65Warnings.ca.gov

MS-Shelves

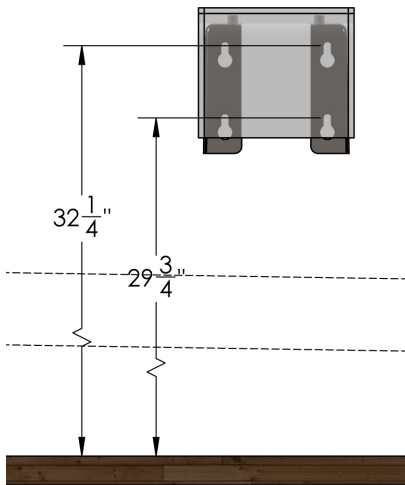
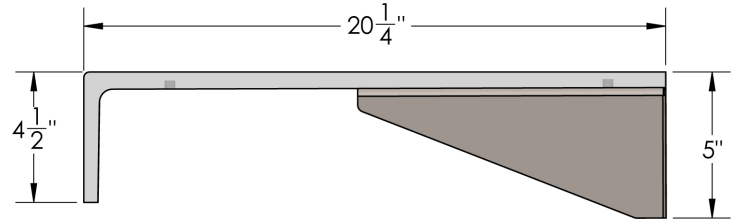
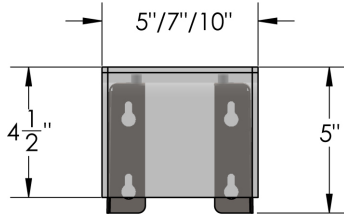

Height Adjustments

Standard	Rim Height	Adjustment of A, B & W
ADA & TAS Adult	34"	None
ADA Juvenile, Age 6-12	31"	Subtract 3" from height in drawing
TAS, Grades 6 through 8 or 9	32"	Subtract 2" from height in drawing
TAS, Grades Pre-K through Grades 5 or 6	30"	Subtract 4" from height in drawing
Alberta and BC Building Code	865 mm	None
Ontario Barrier Free	840 mm	Subtract 24 mm (1") from height in Drawing
Code de Construction Québec	865 mm	Aucune

ES-Shelves

FRONT

SIDE

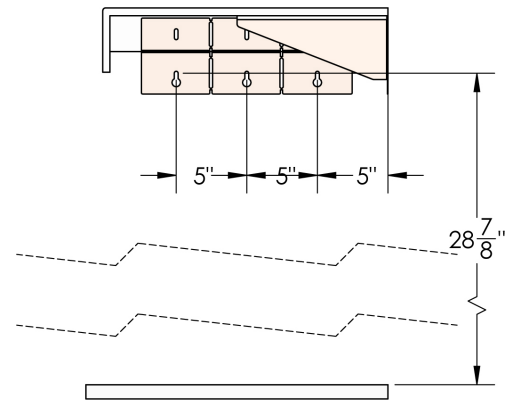
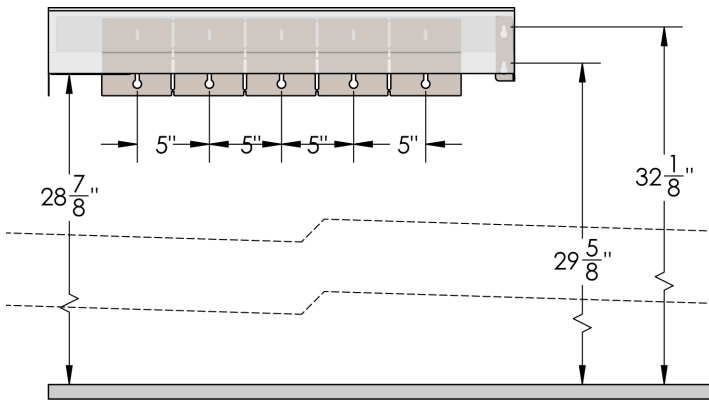
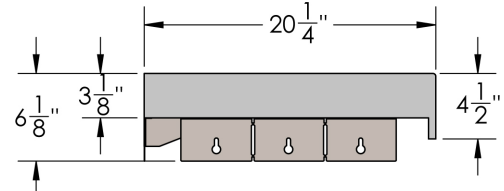
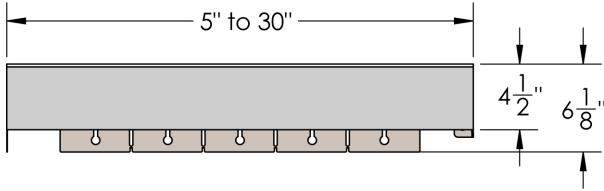

Height Adjustments

Standard	Rim Height	Adjustment of A, B & W
ADA & TAS Adult	34"	None
ADA Juvenile, Age 6-12	31"	Subtract 3" from height in drawing
TAS, Grades 6 through 8 or 9	32"	Subtract 2" from height in drawing
TAS, Grades Pre-K through Grades 5 or 6	30"	Subtract 4" from height in drawing
Alberta and BC Building Code	865 mm	None
Ontario Barrier Free	840 mm	Subtract 24 mm (1") from height in Drawing
Code de Construction Québec	865 mm	Aucune

Carrier Plate

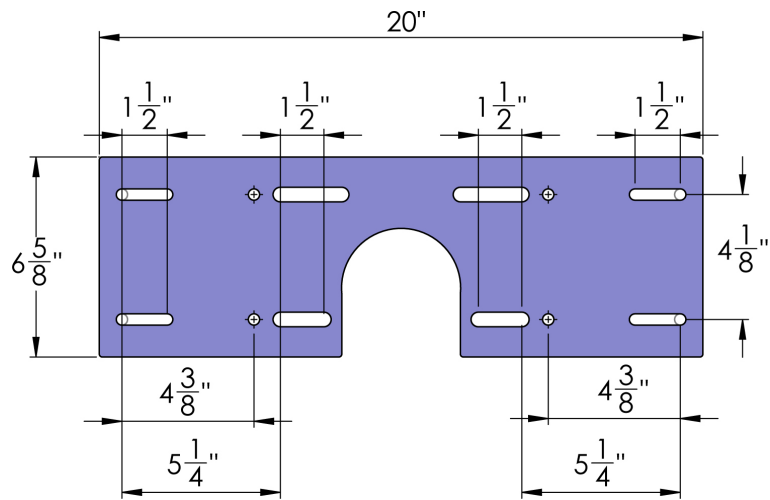

Plate is supplied without fixture support studs or U-bolts. Fits U-bolts with $\varnothing 3/8$ " and ID up to 4"

001	Base Model Number (must specify)	
<input type="checkbox"/>	MVS5	Modus Shelf - 5" Between Fixtures
<input type="checkbox"/>	MVS7	Modus Shelf - 7" Between Fixtures
<input type="checkbox"/>	MVS10	Modus Shelf - 10" Between Fixtures
<input type="checkbox"/>	ESxx	Modus Shelf Wall to Fixture (xx = distance between wall and fixture)
<input type="checkbox"/>	CP	Carrier Plate
002	Color (must specify)	
	<u>Standard Colors</u>	
<input type="checkbox"/>	-AB	Adobe Brown
<input type="checkbox"/>	-AW	Ash White
<input type="checkbox"/>	-CG	Country Green
<input type="checkbox"/>	-CO	Concrete Grey
<input type="checkbox"/>	-DB	Designer Black
<input type="checkbox"/>	-ES	Egyptian Sand
<input type="checkbox"/>	-MB	Midnight Blue
<input type="checkbox"/>	-MG	Misty Grey
<input type="checkbox"/>	-PB	Pearl Black
<input type="checkbox"/>	-PW	Polar White
<input type="checkbox"/>	-SA	Sandstone
<input type="checkbox"/>	-TG	Twilight Grey
	<u>Designer Colors</u>	
<input type="checkbox"/>	-AC	Amalfi Coast
<input type="checkbox"/>	-BB	Belgian Blue
<input type="checkbox"/>	-BF	Black Forrest
<input type="checkbox"/>	-CA	Carrara Grey
<input type="checkbox"/>	-CC	Cebolla Creek
<input type="checkbox"/>	-CP	Caledonia Pearl
<input type="checkbox"/>	-PC	Portofina Crema
<input type="checkbox"/>	-PS	Paris Stone
<input type="checkbox"/>	-RS	San Cristobal Silver
<input type="checkbox"/>	-SR	Sydney Rock Oyster
<input type="checkbox"/>	-UB	Ubatuba Brown
<input type="checkbox"/>	-VM	Vienna Mist
003	Trash Can Opening (for shelves longer than 10" only)	
<input type="checkbox"/>	-TCR	Round Trash Can opening
<input type="checkbox"/>	-TCL	Square Trash Can opening

Approved by:

Name: _____

Title: _____

Signature: _____

All information including dimensions, changes in design and material are subject to manufacturer's change without formal notice and without obligation. AquaDesign assumes no responsibility for use of superseded or voided information. Verify all rough-in information before installation. It is the responsibility of the installer to conform with local and national codes.